

eclipse®

S T A I N L E S S

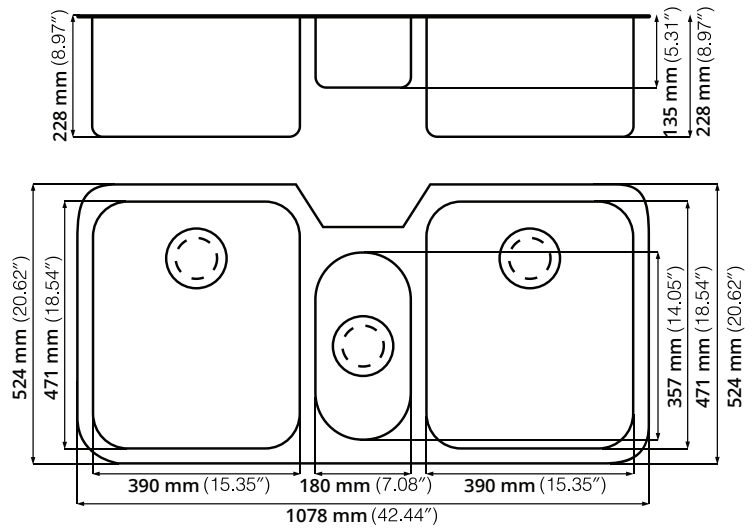

100% a cero
inoxidable



10 años
de garantía



libre
de plomo

598

SUBMONTAR ARCHITECT

Acero serie: 304

Calibre: 16

Profundidad de tarja: 228 y 135

Acabado: Cepillado

Medida mínima de gabinete: 110 cm